

**iBLD45W-S**

**External Rotor Series  
Driver User Manual**

**Versions: V1.00**

All the Copyrights cannot be reprinted  
[ Please read this manual carefully before use to avoid damaging the driver ]



## Contents

1. Product introduction.....	3
1.1. Introduction.....	3
1.2. Characteristics.....	3
1.3. Application Fields.....	3
2. Electrical, Mechanical and Environmental Indicators.....	4
2.1. Electrical index.....	4
2.2. Use environment and parameters.....	4
2.3. Mechanical structure dimension diagram.....	5
2.4. Heat dissipation precautions.....	5
3. Driver interface definition and wiring introduction.....	6
3.1. Interface Description.....	6
3.2. Interface circuit.....	7
3.3. Speed regulation mode control.....	7
3.4. LED Status Indication.....	8
3.5. Wiring requirements.....	8
4. Product warranty clause of FULLING MOTOR.....	9
5. Version Description.....	10



# iBLD45W-S External Rotor Series Driver User Manual

## 1. Product introduction

### 1.1. Introduction

iBLD45W-S External Rotor Series Driver is a high-performance motor driver independently developed by CHANGZHOU FULLING MOTOR CO., LTD. It adopts a 32-bit dedicated motor control chip, with high integration, small size, and complete protection measures. This motor adopts a new PWM control technology, which makes the brushless motor operate with advantages such as high rotation, low vibration, low noise, and good smoothness.

### 1.2. Characteristics

- Adopting a dedicated 32-bit motor control chip
- Adopting FOC magnetic field orientation control technology and SVPWM (space vector modulation technology)
- Input voltage 9VDC~30VDC, wide voltage input
- Supports multiple speed regulation modes (PWM/analog)
- Equipped with control functions such as start stop, forward and reverse rotation, braking, etc
- High precision speed and current dual closed-loop control
- It has protection functions such as overvoltage, undervoltage, overcurrent, overtemperature, and locked rotor
- Ultra high cost-effectiveness, economically efficient
- Acceptable customization

### 1.3. Application Fields

Widely used in various small and medium-sized automation equipment and



instruments, such as electronic processing equipment, 3C non-standard automation equipment, screw locking machines, wire stripping machines, winding machines, terminal machines, laser machines, marking machines, spray painting machines, small and medium-sized carving machines, automatic grabbing equipment, specialized CNC machine tools, packaging equipment and robots.

## 2. Electrical, Mechanical and Environmental Indicators

### 2.1. Electrical index

Parameters	Index			
	Minimum value	Typical value	Maximum value	Unit
Power supply voltage	9	12/24	30	Vdc
Continuous output current	0	3.26	7.0	A
Logic input voltage	0	5	24	Vdc
Analog input voltage	0	-	5	Vdc
Output logic voltage	0	-	5	Vdc
Output logic current (Charging current)	0	30	50	mA
Output sensor voltage	4.5	5	5.5	Vdc
Output sensor current	0		30	mA
PWM pulse frequency	1	-	20	kHz

### 2.2. Use environment and parameters

Parameters	Index
Temperature	-20°C ~ 50°C
Humidity	40 ~ 90%RH (No condensation)

Vibration	< 55Hz / 0.15mm
On site environment	Avoid approaching other heat sources, avoid dust, oil mist, corrosive gases, places with high humidity and strong vibrations, and prohibit the presence of combustible gases and conductive dust
Storage temperature	-20°C ~ 65°C
Type of cooling	Natural cooling or forced air cooling

### 2.3. Mechanical structure dimension diagram

#### 2.3.1 Mechanical dimension diagram

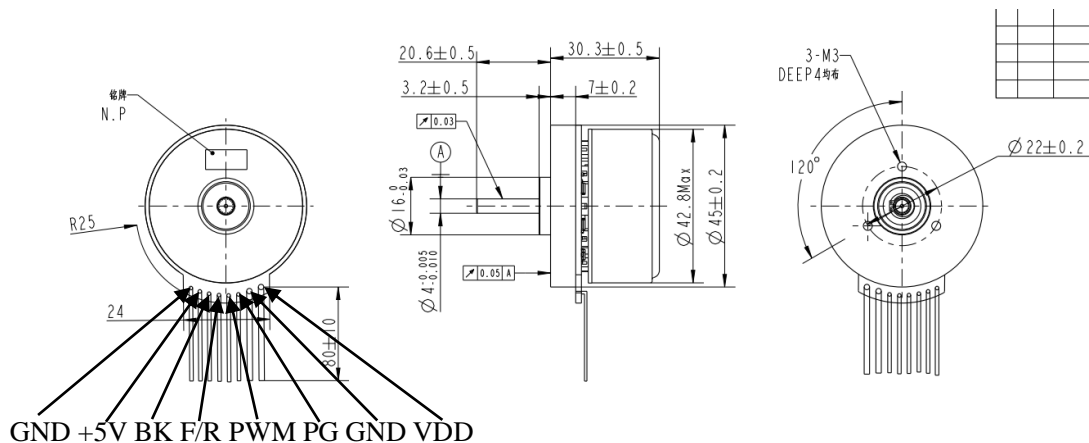

FIG. 1 Mechanical dimensions

### 2.4. Heat dissipation precautions

The reliable working temperature of IBLD45W-S External Rotor Series Driver is usually within 80 °C. When installing, please use an upright side installation to create strong air convection on the surface of the heat sink. If necessary, install a fan near the driver to forcibly dissipate heat, ensuring that the driver operates within a reliable working temperature range.



### 3. Driver interface definition and wiring introduction

#### 3.1. Interface Description

##### 3.1.1 Control Port (B08B-PASK-1(LF)(SN) 8-bit pin)

Pin number	signal	function	Explanation
1	GND	Sensor power supply Ground	Sensor power supply ground, shared with main power supply ground
2	+5V	Sensor +5V power supply	Sensor +5V power supply, Output current $\leq 30\text{mA}$
3	BK	Brake signal	Invalid when suspended or connected to a high level (1.7V~24V) Connected to low-level brake effective (0V~0.8V)
4	F/R	Directional signal	CW\CCW High and low level polarity can be configured by software High level (1.7V~24V) Low level (0V~0.8V)
5	SV/PWM	Speed regulation signal	Analog speed control: 0.5V~4.5V, PWM speed regulation: Duty cycle polarity configurable 0~5% Full speed 5~95% Linear speed regulation 95~100% cease
6	PG	Speed signal	TTL-5V level, 1 pulse /1 Antipolar / rotate
7	GND	Power input negative terminal	Negative pole of power input
8	VDD	Positive pole of power supply	Power input positive terminal, input voltage 9V~30Vdc

### 3.2. Interface circuit

Input signal of iBLD45W-S external rotor series driver

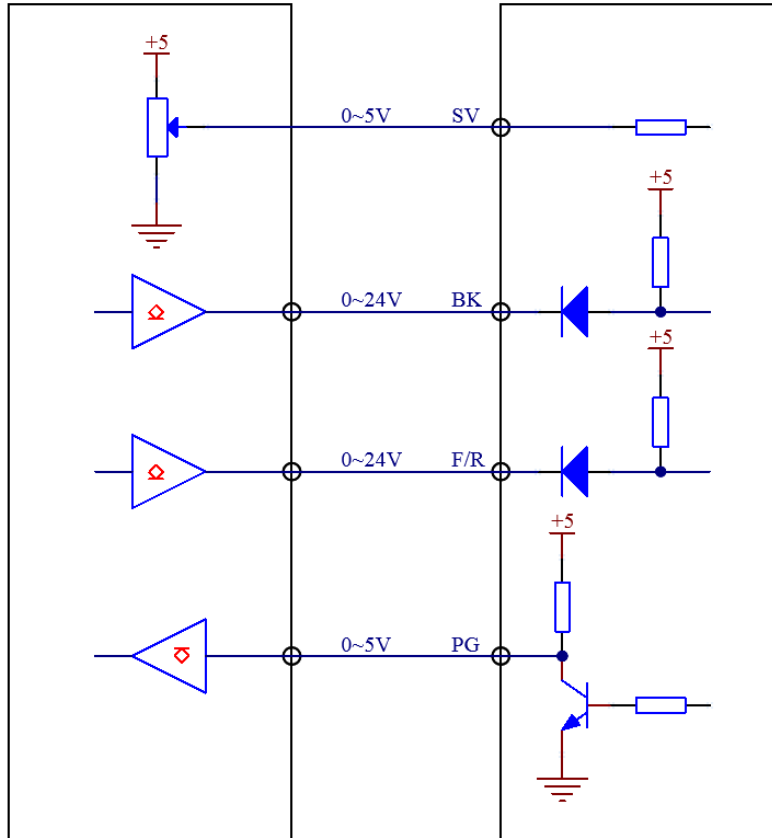

FIG. 3 Wiring diagram of control signal

### 3.3. Speed regulation mode control

The iBLD45W-S external rotor series driver offers two speed control modes that users can choose from (configured through software):





External analog speed regulation: An analog signal with an amplitude of 0-5V can be applied between SV/PWM and GND, stopping at 0-0.5V, linear speed regulation at 0.5-4.5V, and maximum speed operation at 4.5-5V.

External PWM speed regulation: A pulse width digital signal (PWM) with an amplitude of 3.3-5V and a frequency of 1KHz-20KHz can be applied between SV/PWM and GND for speed regulation, and the motor speed is linearly adjusted by its duty cycle. 0%~5% full speed operation, 5%~95% linear speed regulation, 95%~100% stop.

### 3.4. LED Status Indication

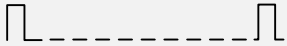
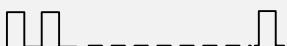
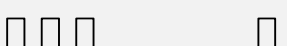
The green LED is the power indicator light. When the motor is powered on, the green LED stays on; Cut off the power and the green LED will turn off.

The red LED is the fault indicator light. When a fault occurs, the red indicator light flashes for a period of 500ms (Duty 50%), and then turns off for 1.5s, repeating the cycle; When the fault is cleared by the user, the red LED remains off. The flashing frequency of the red LED represents different fault information, as shown in the table below.

Serial number	Flashing frequency	Red indicator light flashing waveform	Fault Description
1	0	Red light goes out	No faults
2	1		Overcurrent fault
3	2		Undervoltage fault
4	3		Overvoltage fault
5	4		Over temperature fault
6	5		HALL malfunction
7	6		Motor blocking protection

### 3.5. Wiring requirements

- 1) To prevent interference with the driver, it is recommended to use shielded cables for control signals, and the shielding layer should be short circuited to the ground wire. Unless otherwise specified, the shielding wire of the control signal cable should be grounded at one end: the upper computer end of the shielding wire should be grounded, and the driver end of the shielding wire should be suspended. Grounding is only allowed at the same point within the same machine. If it is not a true grounding wire, it may cause serious interference, and the shielding layer is not connected at this time.





- 2) If a power supply supplies multiple drives, parallel connection should be adopted at the power supply, and chain connection from one to another is not allowed.
- 3) It is strictly prohibited to plug and unplug the driver terminals with electricity. When a live motor stops, there is still a large current flowing through the coil, and plugging and unplugging the terminals will cause a huge instantaneous induced electric potential that will burn out the driver.
- 4) It is strictly prohibited to solder the wire head and connect it to the wiring terminal, otherwise it may overheat and damage the terminal due to increased contact resistance.
- 5) The wiring terminal should not be exposed outside the terminal to prevent accidental short circuit and damage to the driver.

## **4. Product warranty clause of FULLING MOTOR**

### **1) One year warranty**

FULLING provides a one-year warranty against defects in the raw materials and workmanship of its products from the date of shipment. During the warranty period, FULLING provides free repair service for defective products.

### **2) Not covered by warranty**

A、 Inappropriate wiring, such as reversed polarity of the power supply and live plugging and unplugging

B、 Unauthorized modification of internal components

C、 Use beyond electrical and environmental requirements

D、 Poor environmental heat dissipation

### **3) Repair process**

If the product needs to be repaired, the following process will be followed:

(1) Before shipping, please call the customer service personnel of FULLING to obtain a repair permit number;

(2) Please send a written explanation along with the goods, explaining the



phenomenon of the faulty drive being repaired; The voltage, current, and usage environment at the time of the malfunction; The name, phone number, and mailing address of the contact person.

(3) Prepaid postage to CHANGZHOU FULLING MOTOR Co., Ltd., No. 69 Kunlun Road, Xinbei District, Changzhou City, Jiangsu Province  
Postal code: 213032.

#### 4) Warranty Limitations

A、 The warranty scope of FULLING's products is limited to the components and processes of the products (i.e. consistency)

B、 FULLING does not guarantee that its products will be suitable for the specific use of customers, as the suitability is also related to the technical specifications, usage conditions, and environment of the use.

#### 5) Maintenance requirements

When repairing, please truthfully fill out the "Repair Report" (this form can be downloaded from [www.fullingmotor.com](http://www.fullingmotor.com)) for maintenance analysis. Mailing address: CHANGZHOU FULLING MOTOR Co., Ltd., No. 69 Kunlun Road, Xinbei District, Changzhou City, Jiangsu Province. Postal code: 213032.

## 5. Version Description

Version number	Summary of Revision Content	date
V1.0	Create	2024-5-31



---

常州富兴机电有限公司

地址: 江苏省常州市新北区昆仑路 69 号

邮编: 213032

电话: +86-519-85132957

传真: +86-519-85132956

邮箱: [info@fullingmotor.com](mailto:info@fullingmotor.com)

